

# **OPTOIO-PCI16 STANDARD**

**EDV-No.: A-429200**

16 optocoupler isolated digital inputs  
16 optocoupler isolated digital outputs

**wasco<sup>®</sup>**

user's guide

## Copyright© 2002-2011 by Messcomp Datentechnik GmbH

This documentation is copyright by Messcomp Datentechnik GmbH. All rights are reserved.

Messcomp Datentechnik GmbH reserves the right to modify the products described in this manual at any time and without preannouncement.

No parts of this manual are allowed to be reproduced, copied, translated or transmitted in any way without a prior written consent of Messcomp Datentechnik GmbH.

## Registered Trademarks

IBM PC, PC/XT and PC/AT are registered trademarks of International Business Machines (IBM).

BASIC is registered trademark of Dartmouth College.

Turbo Pascal, Turbo C are registered trademarks of Borland.

Quickbasic is trademark of Microsoft.

Powerbasic is trademark of Robert S. Zale.

**wasco**® is registered trademark.

## Disclaimer

The company Messcomp Datentechnik GmbH assumes no liability for the use of the interface card OPTOIO-PCI16<sub>STANDARD</sub> and this documentation, neither for direct nor indirect damages.

# Table of Contents

- 1. Description**
- 2. Installation of OPTOIO-PCI16<sub>STANDARD</sub>**
  - 2.1 Installing the card into your system
- 3. Connectors**
  - 3.1 Position of the connector plugs on the board
  - 3.2 Pin assignment of CN1
  - 3.3 Pin assignment of CN2
  - 3.4 Pin assignment of CN2 on D-Sub 37 flat ribbon cable (cable not included)
- 4. System Components**
  - 4.1 Block diagram
  - 4.2 Access to the system components
- 5. 16 Optocoupler Isolated Digital Inputs**
  - 5.1 Pin assignment of the input optocouplers
  - 5.2 Input voltage ranges
- 6. 16 Optocoupler Isolated Digital Outputs**
  - 6.1 Pin assignment of the output optocoupler
  - 6.2 Optocoupler specification
- 7. DOS® Programming**
  - 7.1 Programming of the OPTOIO-PCI16<sub>STANDARD</sub>
  - 7.2 Assignment of port addresses
- 8. Windows® Programming**
  - 8.1 Programming of the OPTOIO-PCI16<sub>STANDARD</sub>
  - 8.2 Installation of Windows® driver
- 9. Accessories**
  - 9.1 Suitable **wasco®** accessories
  - 9.2 Connecting technique (samples)
  - 9.3 Single components for own assembly

**10. Troubleshooting**

**11 Specifications**

**12. Product Liability Act**

**13. CE Declaration of Conformity**

## 1. Description

The **wasco**<sup>®</sup> interface card OPTOIO-PCI16<sub>STANDARD</sub> provides 16 digital inputs and 16 digital outputs, each channel is opto-isolated galvanically isolated by optocouplers of high quality. All input optocoupler have integrated schmitt trigger function. Special high power output optocouplers manage a maximum switching current of 150 mA. Each input or output is fitted with additional protection diodes against harmful voltage peaks. You can adjust two different voltage ranges by resistors easily to change and plug in. Output optocouplers are led to a 37 pin D-Sub jack mounted to the board's slot bracket. Optocoupler inputs are fed to a 40-pin box header. A special available cable (set of female connector, ribbon cable and 37pin female sub-D-connector with slot bracket) can postpone connection to a slot of your PC casing. Pin assignment and input voltage ranges are identical with ISA bus card OPTOIO-16<sub>STANDARD</sub>. Therefore a switch to PCI is easily to realise.

## **2. Installation of OPTOIO-PCI16<sub>STANDARD</sub>**

### **2.1 Installation of the card into your system**

Before you insert the card unplug the power cord or make sure, there is no current to/in the computer. Inserting in a running system may cause damaging or destroying not only OPTOIO-PCI16<sub>STANDARD</sub>, but even other already inserted cards of your computer.

Select an empty PCI slot of your computer. Please refer to the computer's manual for support. Secure the OPTOIO-PCI16 from loss of connection by screwing the mounting bracket to the casing of the computer.

### 3. Connectors

#### 3.1 Position of the connector plugs

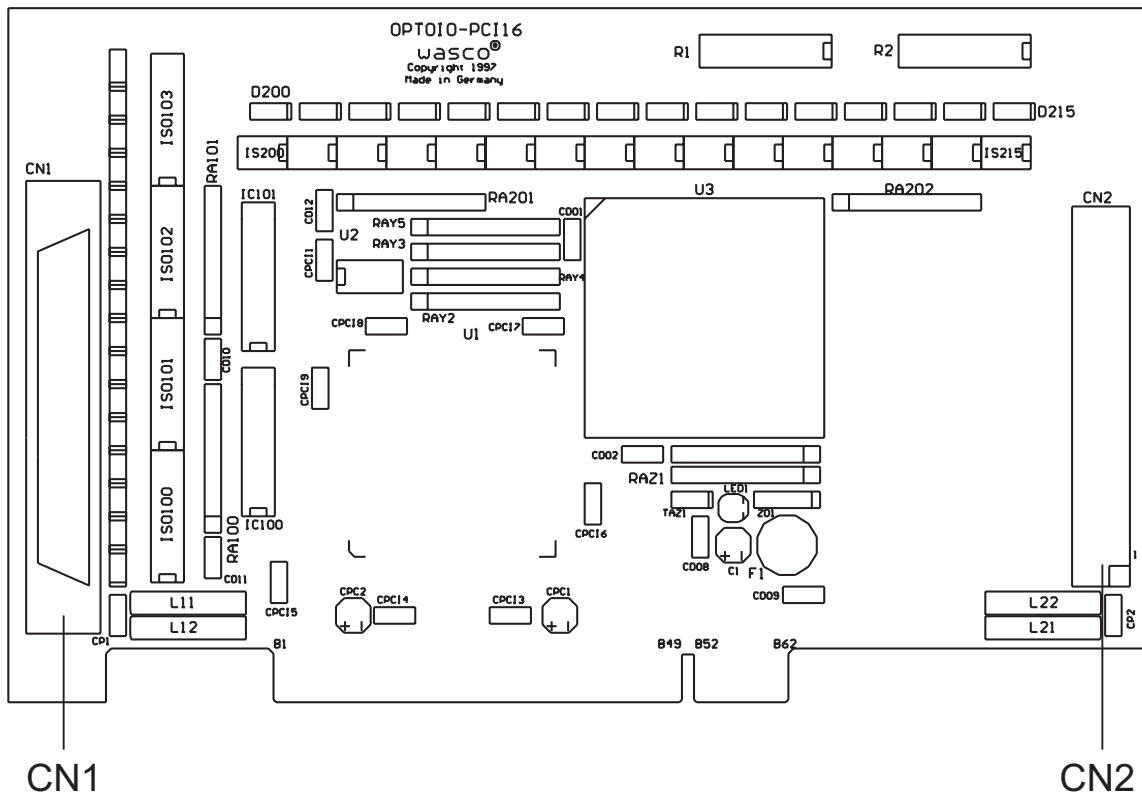

- CN1: Optocoupler Outputs OUT00...OUT15
- CN2: Optocoupler Input IN00...IN15

## 3.2 Pin assignment of CN1

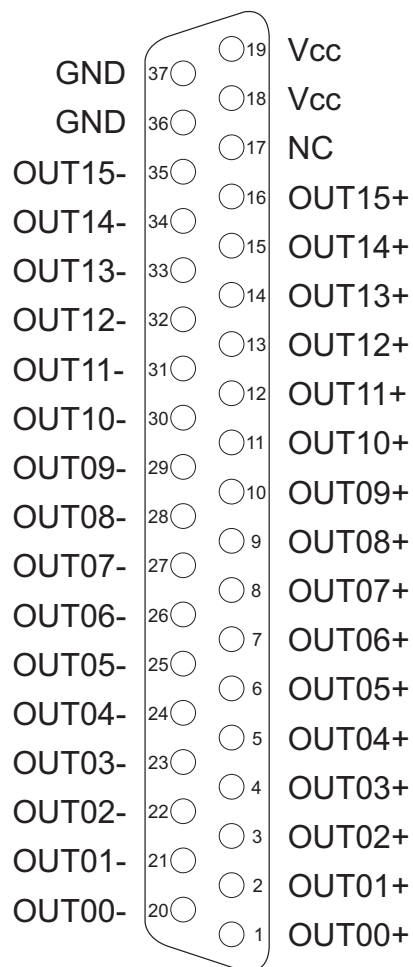

**Vcc:**

Connector for internal voltage source (+ 5V) (an inductor must be soldered on L11), **never apply an external voltage across this pin**

**GND:**

Ground connection (only when an inductor is soldered on L12)

**NC:**

not connected



### 3.3 Pin assignment of CN2

NC	40	39	NC
NC	38	37	Vcc
GND	36	35	Vcc
GND	34	33	NC
IN15-	32	31	IN15+
IN14-	30	29	IN14+
IN13-	28	27	IN13+
IN12-	26	25	IN12+
IN11-	24	23	IN11+
IN10-	22	21	IN10+
IN09-	20	19	IN09+
IN08-	18	17	IN08+
IN07-	16	15	IN07+
IN06-	14	13	IN06+
IN05-	12	11	IN05+
IN04-	10	9	IN04+
IN03-	8	7	IN03+
IN02-	6	5	IN02+
IN01-	4	3	IN01+
IN00-	2	1	IN00+

**Vcc:**

Connector for internal voltage source (+ 5V) (an inductor must be soldered on L21), **never apply an external voltage across this pin**

**GND:**

Ground connection (only when an inductor is soldered on L22)

**NC:**

not connected

## 3.4 Pin assignment of CN2 on D-Sub37 flat ribbon cable

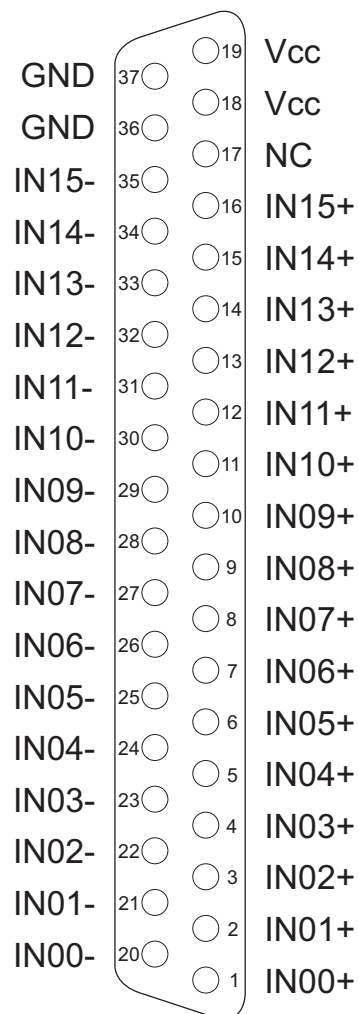

### Vcc:

Connector for internal voltage source (+ 5V) (an inductor must be soldered on L21), **never apply an external voltage across this pin**

### GND:

Ground connection (only when an inductor is soldered on L22)

### NC:

not connected

## 4. System Components

### 4.1 Block diagram

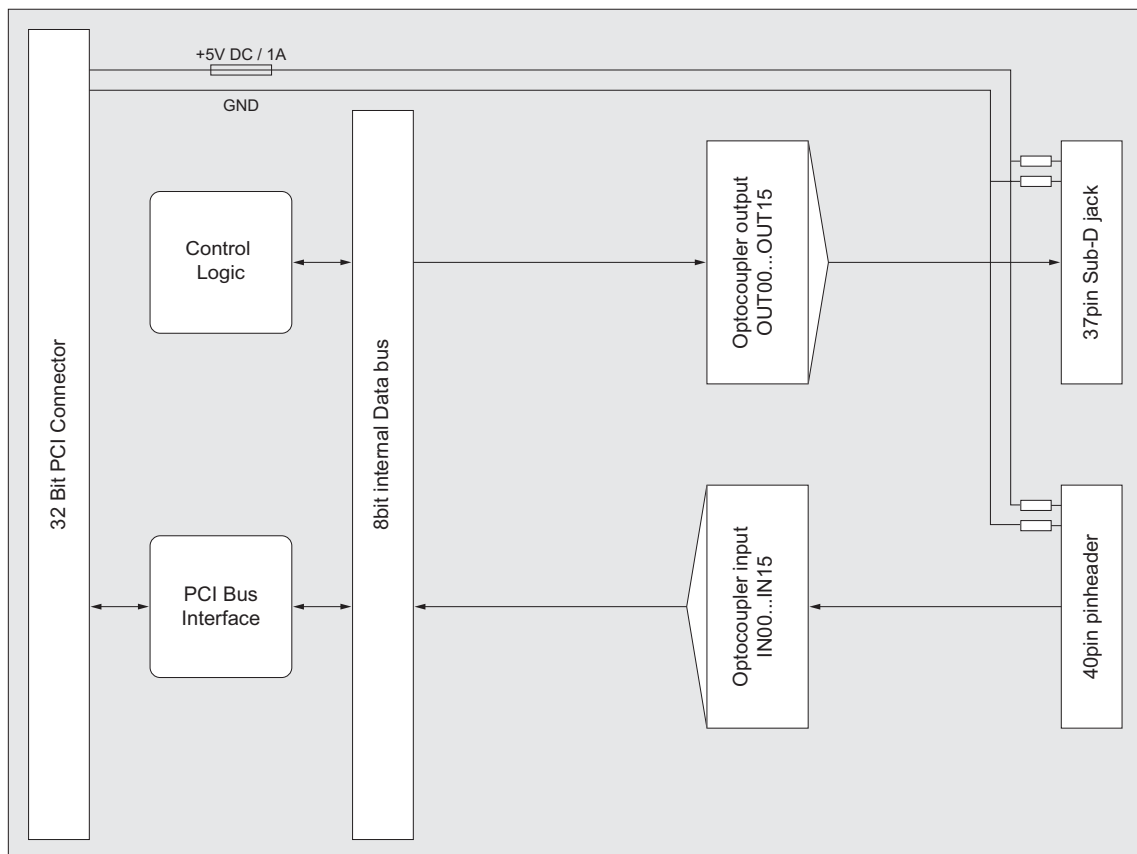

## 4.2 Access to the system components

Access to the hardware components is made by reading and writing port addresses by library functions. The relevant port addresses for OPTOIO-PCI16 depend on the base address given by the PCI BIOS. Port access to the OPTOIO-PCI16 is made by byte access (8 Bit) only, word or double word accesses are not suitable. (Please find more information in chapter Programming or in samples on the enclosed CD)

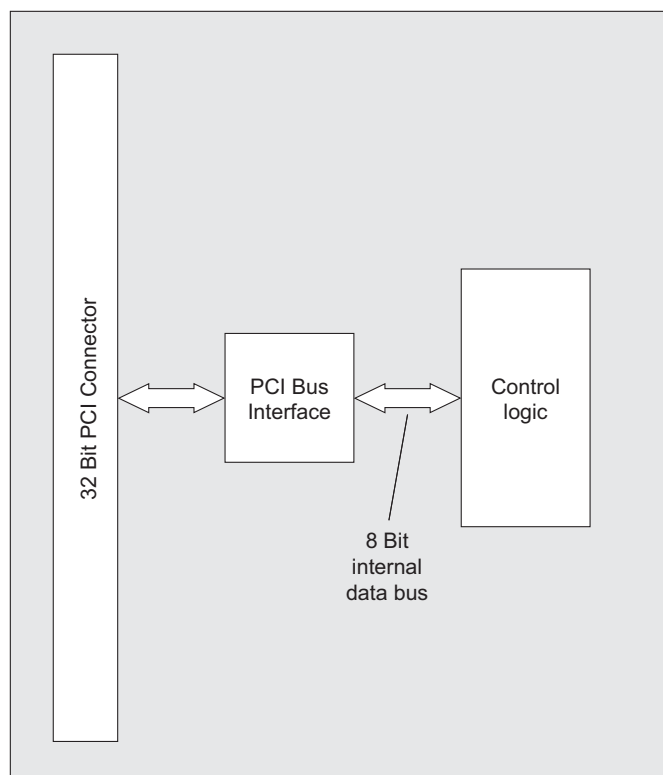

## 5. 16 Optocoupler Isolated Digital Inputs

The OPTOIO-PCI16<sub>STANDARD</sub> provides 16 input channels which are optically isolated. The isolation voltage between GND and input is 500 V<sub>DC</sub>. The voltage within the input channels is limited to 100 V<sub>DC</sub>.

### 5.1 Pin assignment of the input optocouplers

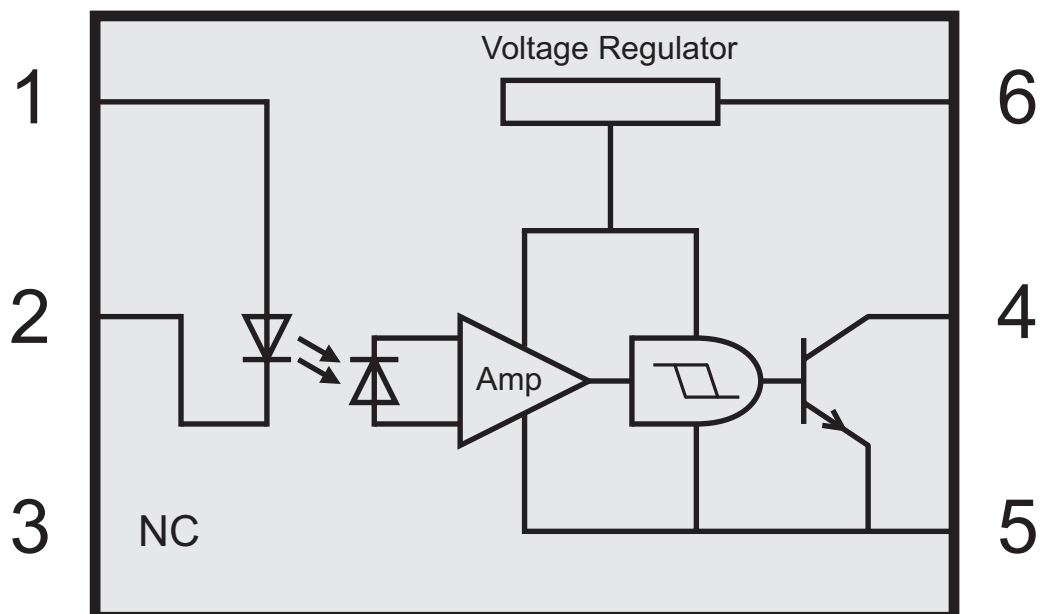

## 5.2 Input voltage ranges

Two different input voltage ranges can be selected by interchanging the resistor arrays R1 and R2.

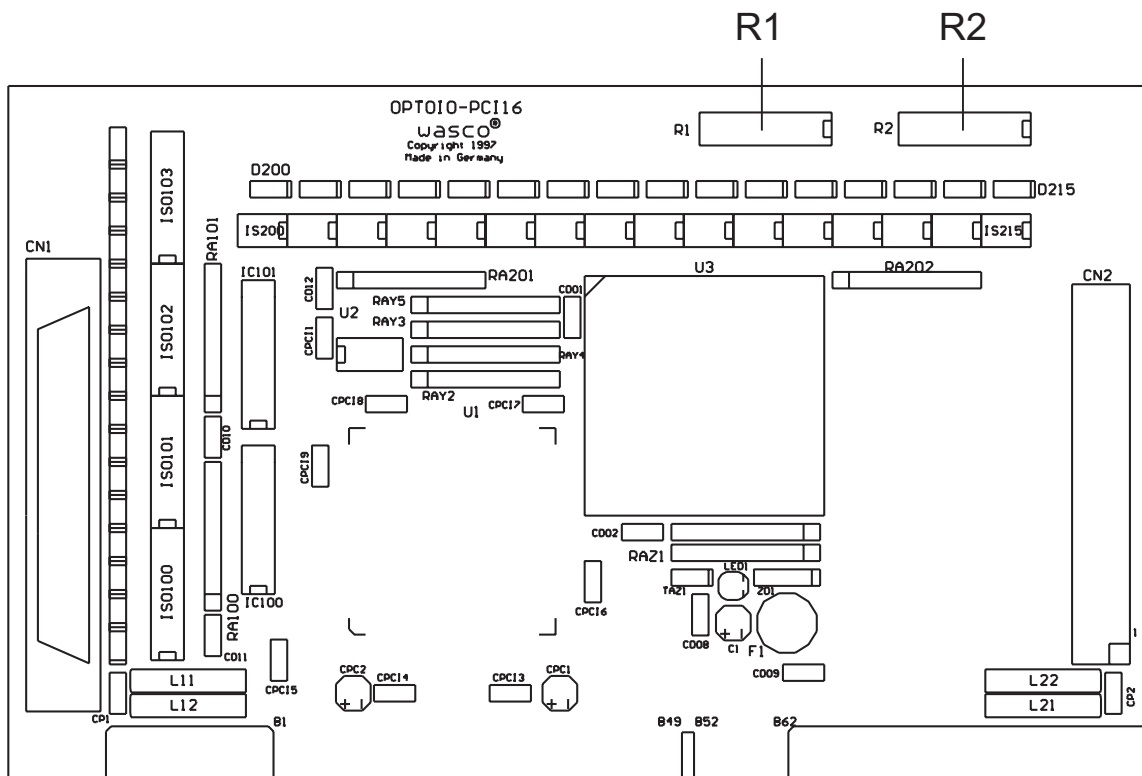

Following table shows the data of the two input voltage ranges:

Resistor R1, R2	Identifier	low	high
1,0 KOhm	102	0...1,5 V	2,2...15 V
4,7 KOhm	472	0...4,0 V	7,0...30 V

## 6. 16 Optically Isolated Outputs

The OPTOIO-PCI16<sub>STANDARD</sub> provides 16 output channels, which are optically isolated by optocouplers. The isolation voltage between GND and the output ist 500 V<sub>DC</sub>.

### 6.1 Pin assignment of the output optocoupler

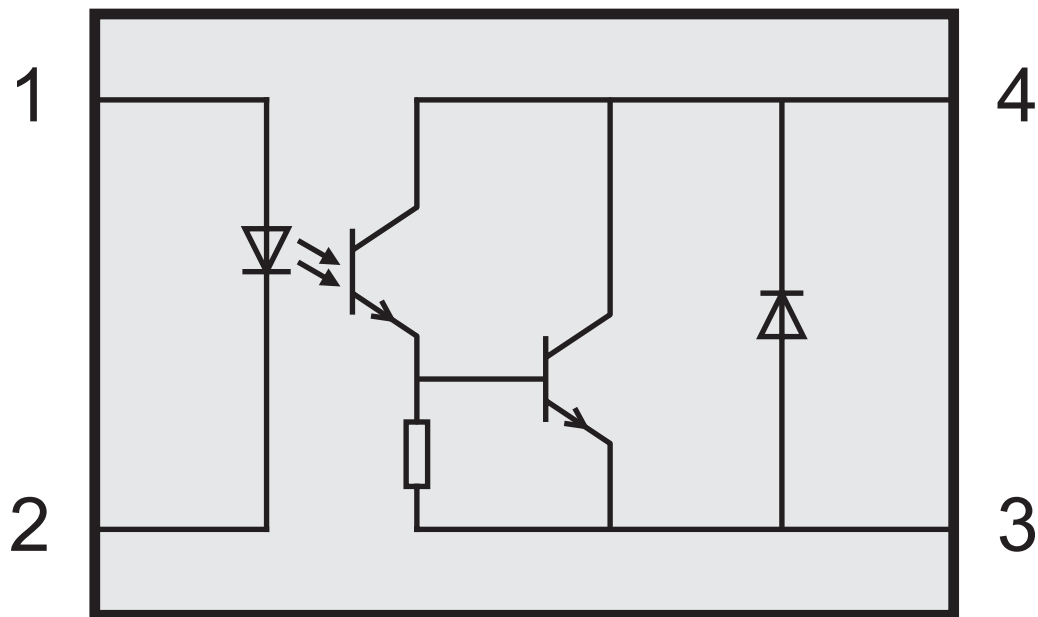

### 6.2 Optocoupler specifications

Voltage collector - emitter:	max. 50V
Voltage emitter - collector:	0,1V
Current collector - emitter:	150 mA

## 7. DOS<sup>®</sup> Programming

### 7.1 Programming of the OPTOIO-PCI16

In the enclosed software you can find library functions and programming samples to access OPTOIO-PCI16 under DOS<sup>®</sup>. Hardware components are programmed by access to port addresses. These addresses depend on the I/O base address (and LC base address) issued by the PCI BIOS. Initializing routines can help to determine I/O base address, LC base address as well as the port addresses of each single hardware component. Additionally you can access to further information, such as IRQ number, localisation of the card in your bus system and card version. If you work in a programming language not (yet) providing library functions, the program OIOSCAN (-> in directory UTIL) can help to determine the PCI parameter of OPTOIO-PCI16.

#### **PCI parameters:**

- I/O base address
- IRQ number
- LC base address
- Bus number
- Device number
- Function number
- OPTOIO version

#### **PCI identification:**

Device ID	=	\$9050
Vendor ID	=	\$10B5
Subsystem Vendor ID	=	\$10B5
Subsystem ID	=	\$1149



## 7.2 Assignment of Port Addresses

The port addresses of each hardware component depend on the I/O base address (BA) and LC base address (LC) as follows:

Port/Register	BA + Offset	RD/WR
Optocoupler Input Port A (IN00...IN07)	BA + \$0	RD
Optocoupler Input Port B (IN08....IN15)	BA + \$1	RD
Optocoupler Output Port A (OUT00...OUT07)	BA + \$2	WR
Optocoupler Output Port B (OUT08...OUT15)	BA + \$3	WR

## 8. Windows® Programming

### 8.1 Programming OPTOIO-PCI16<sub>STANDARD</sub>

To apply the card under Windows® a special driver has to be installed, which enables port access to the card.

### 8.2 Installation of Windows® driver

To install Windows® driver please run setup.exe in the directory „Treiber“ on the enclosed CD and then follow installation instructions.

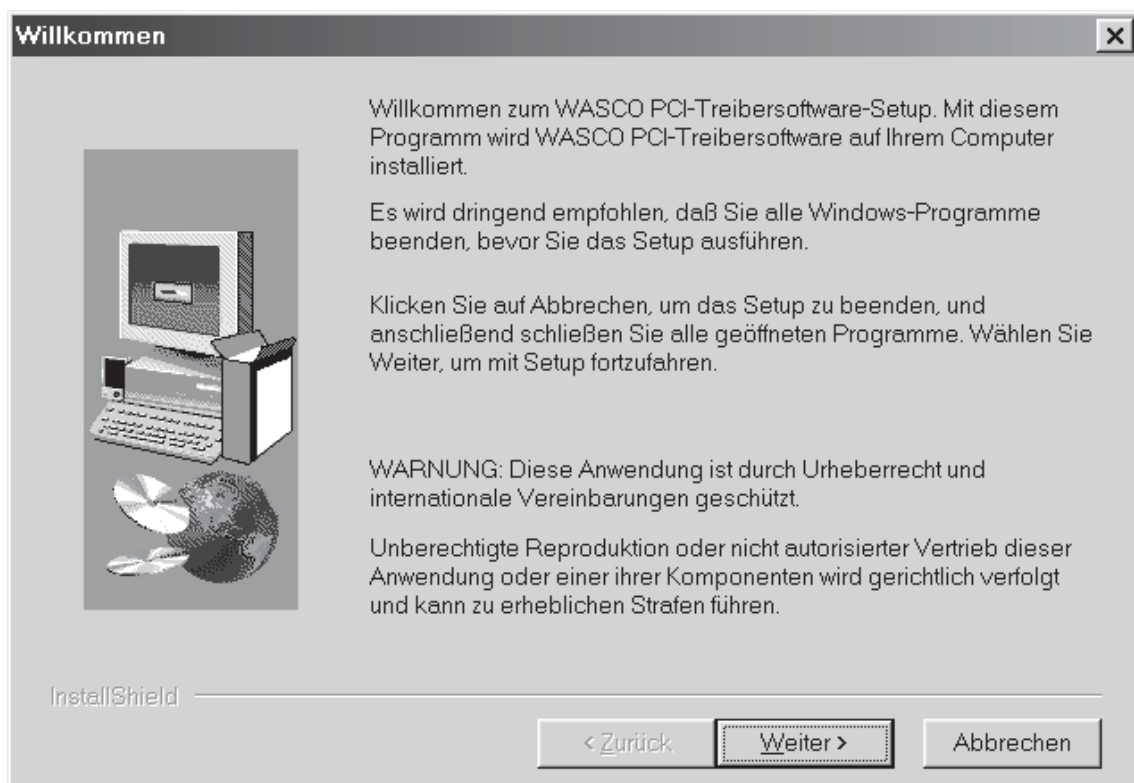

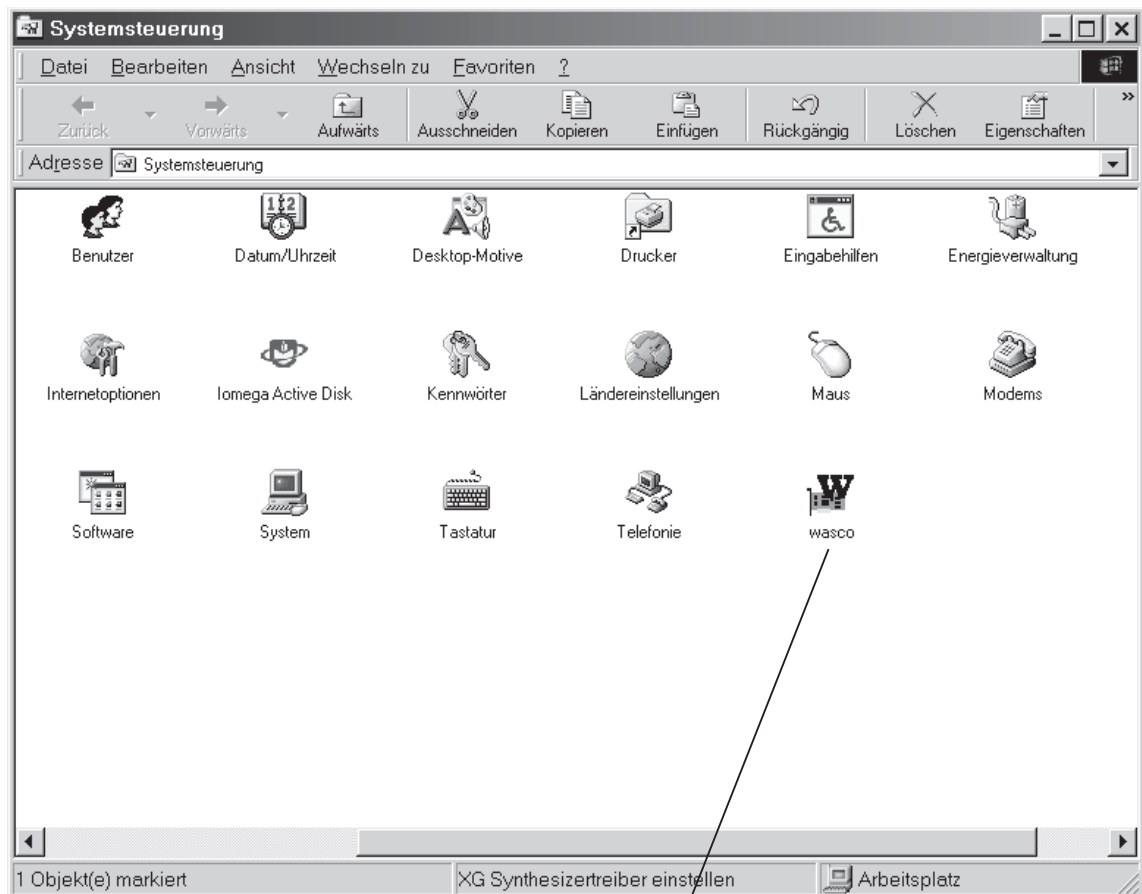

Having installed driver software competely, your system control panel shows an icon for the localisation of all **wasco**® PCI cards existing in the system.

Start the card's monitoring by double-clicking the "**wasco**" icon. Following screen appears (in this example an OPTORE-PCI16 and an ADIODA-PCI12 may be used)

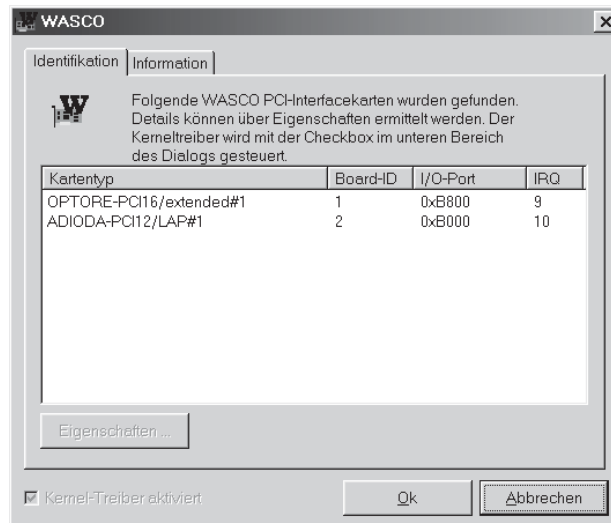

Once the system detected the card, this window shows card name, board ID, I/O address and possible interrupt number for each card. Furthermore the tab „Information“ leads to information about driver version and localisation of the driver file.



If the system did not detect your card, following error messages pop up:

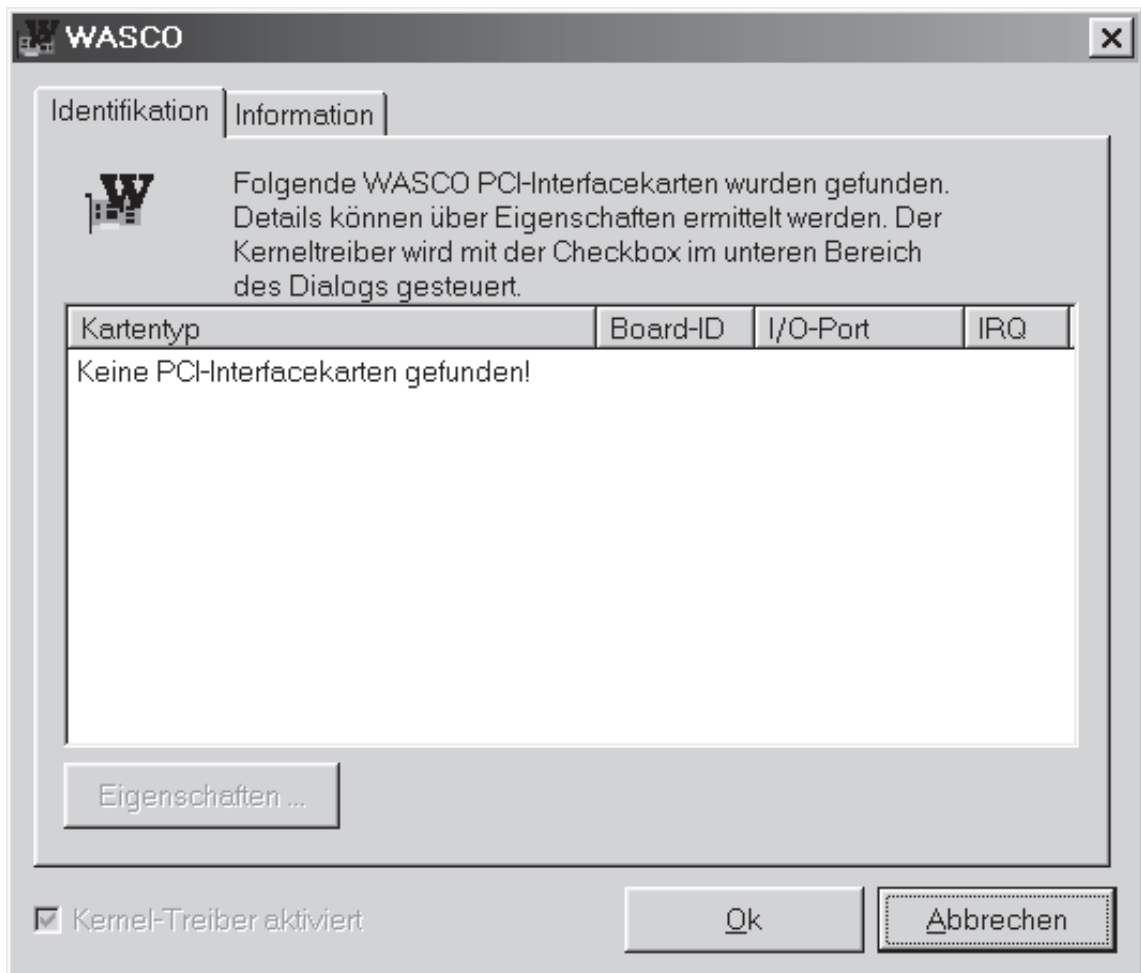
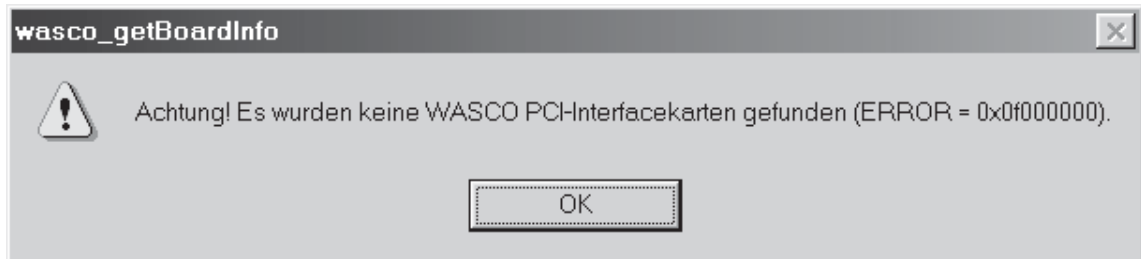

Please search for possible causes in chapter troubleshooting.

## 9. Accessories

### 9.1 Compatible **wasco®** accessories

Connecting parts	EDV-Nr.
PDB37F23PB40 Ribbon cable	A-497500
DS37R100DS37 Connecting wire (1 meter)	A-202200
DS37R200DS37 Connecting wire (2 meters)	A-202400
DS37R500DS37 Connecting wire (5 meters)	A-202800
KMDB-37 Connecting Board (screw clamp with hole grid for soldering)	A-2046
KMDB-37S Connecting Board (without hole grid)	A-204910
XMOD SSR-2 Solid State Relay Module	A-3282
XMOD SSR-4 Solid State Relay Module	A-3284
XMOD REL-4 Relais Module	A-3264
XMOD REL-8 Relais Module	A-3268

### 9.2 Connecting technique (application examples)

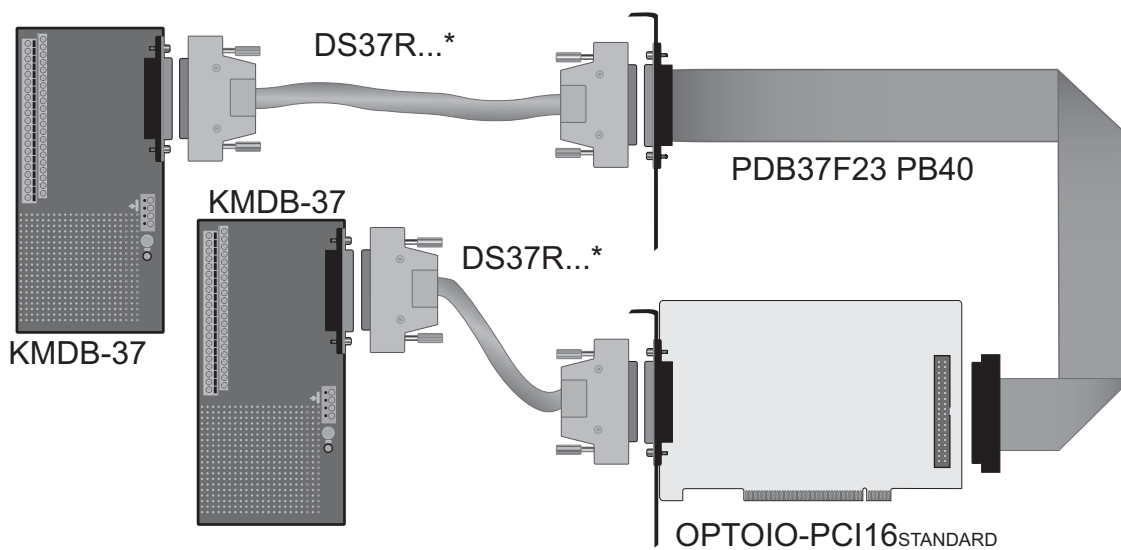

\* DS37R100DS37 or DS37R200DS37  
or DS37R500DS37

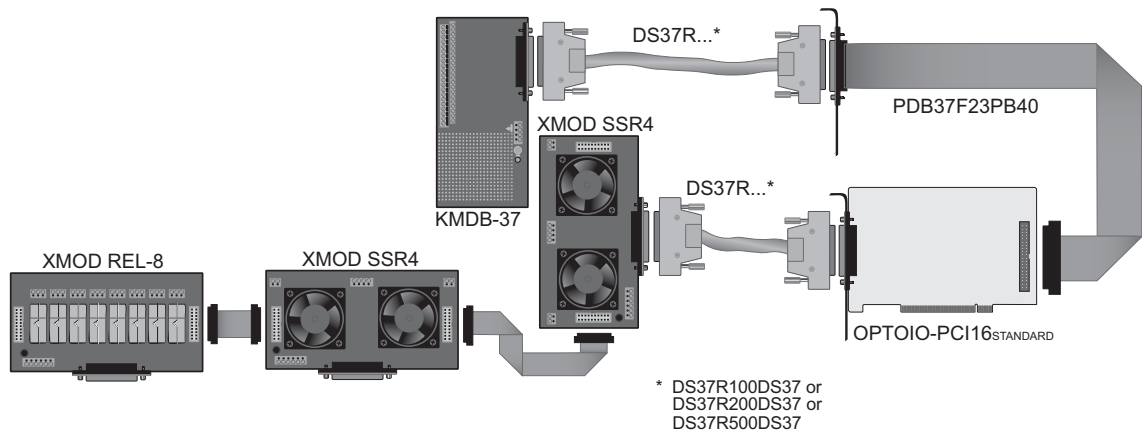

## 9.3 Single components for own Assembly

Connection parts	EDV-No.
D-Sub-plug 37 pin for solder connection	A-5506
Junction shell 37 pin plug (solder connection)	A-5586
D-Sub connector male 37 pin for flat ribbon cable	A-5526
D-Sub connector female 37 pin for flat ribbon cable	A-5566
Slot bracket with cutout for connector male/female 37 pin	A-5754
Box header 40 pin for flat ribbon cable	A-5642
flat ribbon cable 37 pin	A-5718
flat ribbon cable 40 pin	A-5720

## 10. Troubleshooting

Following you can find a short compilation of most known error causes, which can occur while starting-up or running OPTOIO-PCI16.

Please check this list before you contact your dealer or distributor to solve your problem:

1. Is OPTOIO-PCI16 inserted to the PCI slot properly?
2. Are all cable connections alright?
3. Is the fuse F1 blown?
4. Did your system detect the card correctly?  
Please check all settings of your computer or contact your system administrator. (As this are BIOS settings we cannot expand on this issue. We point to your computer systems user guide)
5. Did you install the latest driver-version for the **wasco**<sup>®</sup> drivers?  
Updates you can find here: <http://www.messcomp.com>  
<http://www.wasco.de>





## 10. Product Liability Act

### Information for Product Liability

The Product Liability Act (Act on Liability for Defective Products - Prod-HaftG) in Germany regulates the manufacturer's liability for damages caused by defective products.

The obligation to pay compensation can be given, if the product's presentation could cause a misconception of safety to a non-commercial end-user and also if the end-user is expected not to observe the necessary safety instructions handling this product.

It must therefore always be shown, that the non-commercial end-user was made familiar with the safety rules.

In the interest of safety, please always advise your non-commercial customer of the following safety instructions:

### Safety instructions

The valid VDE-instructions must be observed, when handling products that come in contact with electrical voltage.

Especially the following instructions must be observed:  
VDE100; VDE0550/0551; VDE0700; VDE0711; VDE0860.

The instructions are available from:

Vde-Verlag GmbH  
Bismarckstr. 33  
10625 Berlin

- \* unplug the power plug before you open the unit or make sure, there is no current to/in the unit.
- \* You only may start up any components, boards or equipment, if they are installed inside a secure touch-protected casing before. During installation there must be no current to the equipment.
- \* Make sure that the device is disconnected from the power supply before using any tools on any components, boards or equipment. Any electric charges stored in components in the device are to be discharged prior.
- \* Voltaged cables or wires, which are connected with the unit, the components or the boards, must be tested for insulation defects or breaks. In case of any defect the device must be immediately taken out of operation until the defective cables are replaced.
- \* When using components or boards you must strictly comply with the characteristic data for electrical sizes shown in the corresponding description
- \* As a non-commercial end-user, if it is not clear whether or not the electrical characteristic data given in the provided description are valid for a component you must consult a specialist.

The compliance with building and safety instructions of all kinds (VDE, TÜV, industrial injuries corporation, etc.) are entirely the responsibility of the user/customer.

## 13. CE Confirmation

This is to certify, that the product

**OPTOIO-PCI16<sup>STANDARD</sup>**  
**EDV-Number A-429200**

comply with the requirements of the EC directives. This declaration will lose its validity, if the instructions given in this manual for the intended use of the products are not fully complied with.

EN 5502 Class B  
IEC 801-2  
IEC 801-3  
IEC 801-4  
EN 50082-1  
EN 60555-2  
EN 60555-3

The following manufacturer is responsible for this declaration:

Messcomp Datentechnik GmbH  
Neudecker Str. 11  
83512 Wasserburg

given by

Dipl.Ing.(FH) Hans Schnellhammer  
(CEO)

Wasserburg, 30.05.2006



**Reference system for intended use**

Control Cabinet:	Vero IMRAK 3400	804-530061C 802-563424J 802-561589J
19" Casing:	Vero PC-Casing	145-010108L
19" Casing:	Additional Electronic	519-112111C
Motherboard:	GA-586HX	PIV 1.55
Floppy-Controller:	on Motherboard	
Floppy:	TEAC	FD-235HF
Grafic Card:	Advantech	PCA-6443
Interface:	OPTOIO-PCI16 <sub>STANDARD</sub>	A-429200